



fischer **technik**® u-t 1

Handhabung der Bauelemente des
Grundkastens























Use of basic kit parts

Manipulation des éléments de construction
de la boîte de base

Maneggio degli elementi della cassetta base

Handleiding van de bouwelementen van de
basisdoos

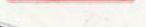
Stückliste ut 1

	Artikel-Nr.	ut 1 Stück	Bezeichnung		Artikel-Nr.	ut 1 Stück	Bezeichnung
	4310011	1	Grundplatte 180×90 · Baseplate 180×90 (5"×3 1/2" approx.) · Plaque de base 180×90 · Piastra fondamentale 180×90 Basisplaat 180×90		4310111	12	Winkelstein gleichschenklig · Angle block, isosceles · Élément angulaire isocèle Elemento a triangolare · Hoeksteen met gelijke benen
	4310021	1	Grundplatte 90×90 · Baseplate 90×90 (3 1/2"×3 1/2" approx.) · Plaque de base 90×90 · Piastra fondamentale 90×90 Basisplaat 90×90		4310101	4	Winkelstein gleichseitig · Angle block, equilateral · Élément angulaire équilatéral Elemento a triangolare equilatero
	3310031	20	Baustein 30 · Building block 30 · Élément de 30 · Elemento 30 · Bouwsteen 30		4315551	4	Flachstein 60 · Flat piece 60 · Plaque de 60 · Elemento piatto 60 · Platte steen 60
	3310041	4	Baustein 30 mit Bohrung · Building block 30 with bore · Élément de 30 percé · Elemento 30 con foro · Bouwsteen 30 met boring		4310131	4	Flachstein 30 · Flat piece 30 · Plaque de 30 · Elemento piatto 30 · Platte steen 30
	3310051	10	Baustein 15 · Building block 15 · Élément de 15 · Elemento 15 · Bouwsteen 15		4315031	2	Bauplatte 30×90 · Building plate 30×90 · Plaque de revêtement 30×90 · Piastra di montaggio 30×90 · Bouwplaat 30×90
	3310061	6	Baustein 15 mit 2 Zapfen · Building block 15 with 2 pegs · Élément de 15 à 2 tenons · Elemento 15 con due appendi neve · Bouwsteen 15 met 2 tappen		4310343	2	Achse 30 · Axle 1 1/4" approx. · Axe 30 · Asse 30 · As 30
	3310071	2	Baustein 15 mit 2 runden Zapfen · Building block 15 with 2 round pegs · Élément de 15 à 2 tourillons · Elemento 15 con due appendi rosse · Bouwsteen 15 met 2 ronde tappen		4310333	2	Achse 50 · Axle 2" approx. · Axe 50 · Asse 50 · As 50
	3310051	2	Baustein 15 mit rundem Zapfen · Building block 15 with round lug · Élément de 15 à tourillon · Elemento 15 con una appendice rosso · Bouwsteen 15 met ronde top (pen)		4310323	4	Achse 60 · Axle 2 1/2" approx. · Axe 60 · Asse 60 · As 60
	4372371	4	Baustein 5 · Building block 5 · Élément de 5 · Elemento 5 · Bouwsteen 5		4373843	2	Achse 80 · Axle 3" approx. · Axe 80 · Asse 80 · As 80
	4372371	4	Baustein 5 · Building block 5 · Élément de 5 · Elemento 5 · Bouwsteen 5		4310313	2	Achse 110 · Axle 4 1/4" approx. · Axe 110 · Asse 110 · As 110
	3310081	2	Gelenkstein · Elbow joint · Élément articulé · Elemento snodato · Scharnierstein		4310811	1	Achshalter · Axle holder · Support d'axe · Supporto per assi · Ashouder
					4310803	1	Kurbelwelle · Crank-shaft · Vilebrequin · Albero a gomiti · Krukas

Stückliste ut 1



























Artikel-Nr.	ut 1 Stück	Bezeichnung	Artikel-Nr.	ut 1 Stück	Bezeichnung
	4310353	4 Winkelachse · Rightangle axle · Axe coudé Asse ad angolo · Haakse as		4310381	2 Nockenscheibe · Cam · Came Piastre di comando · Nokkenschijf
	3310151	4 Flachnabe · Flat hub · Moyeu plat Mozzo piatto · Platte naaf		4357951	4 Seilrolle · Pulley · Poulie · Puleggia Katrol
	3310141	4 Nabe · Hub · Moyeu · Mozzo · Naaf		4376361	1 Rollenlager · Roller bearing · Support de poulie · Cuscinetto a rullo · Rollager
	4310181	4 Reifen 45 · Tyre 45 (1 ³ / ₄ " approx.) Pneu 45 · Copertone 45 · Wielband 45		4310287	1 Antriebsfeder 270 · Drive spring 270 (10 ¹ / ₂ " approx.) · Ressort de trans- mission 270 · Molla per transmissioni 270 Aandrijfveer 270
	4310171	4 Reifen 30 · Tyre 30 (1 ¹ / ₄ " approx.) Pneu 30 · Copertone 30 · Wielband 30		4310241	4 Klemmkupplung · Coupling · Accouple- ment · Giunto di collegamento Klemkoppeling
	4310191	2 Drehscheibe · Disc · Plaque tournante Disco girerole · Draaischijf		3310231	14 Klemmbuchse · Spring clip · Bague de serrage · Bussola di fissaggio · Klembus
	4310221	2 Zahnrad Z 40/32 · Gearwheel Z 40/32 Roue à 40/32 dents · Ingranaggio Z 40/32 Tandwiel Z 40/32		4363341	8 Riegelscheibe · Blocking washer · Disque d'arrêt · Disco a tacche · Grendelschijf
	4310211	2 Zahnrad Z 20 · Gearwheel Z 20 · Roue à 20 dents · Ingranaggio Z 20 · Tandwiel Z 20		3310441	1 Kardangelen · Universal joint · Accouple- ment cardan · Snodo cardanico Kardankoppeling
	3310471	2 Ritzel Z 10 mit Spannzange · Pinion with 10 screw clamp Z 10 · Pignon Z 10 avec écrou de serrage · Ingranaggio Z 10 · Rondsel (klein tandwiel) Z 10 met spantang		4310261	2 Handkurbel · Crank · Manivelle Manovelle · Handkruk
	3310511	2 Kegelhahnrad · Bevel gear wheel · Pignon conique · Ingranaggio conico Kegeltandwiel		4310161	2 Seiltrommel · Winch drum · Tambour Tamburo per funicella · Katroltrommel
	4310531	2 Zahnstange 60 · Gear-rack 60 (2 ¹ / ₂ "") Crémaillère 60 · Asta dentata 60 Tandstang 60		4310201	4 Klemmring für Seiltrommel · Locking ring for winch drum · Flasque de serrage pour tambour · Anello di fissaggio · Klemmring voor kabeltrommel
	4310541	2 Zahnstange 30 · Gear-rack 30 (1 ¹ / ₄ "") Crémaillère 30 · Asta dentata 30 Tandstang 30		4382251	2 Haken · Hook · Crochet · Gancio · Haak
				4310601	4 Verbindungsstück 15 · Connector 15 Languette d'assemblage 15 · Raccordo 15 Verbindingsstuk 15
				4360517	4 Gummiring für Reifen 45 · Rubberring for hoop 45 Elastique pour pneumatique 45 · Anello elastico per cerchio 45 · Rubberring voor band 45

Abb. 1-3 Zusammenfügen der Grundbausteine
 Abb. 4-7 Verbindung von Grundbausteinen mit Verbindungsstücken
 Abb. 8 Drehgelenk mittels Baustein 15 mit rundem Zapfen
 Abb. 9-10 Zusammenfügen von Grundbausteinen und Winkelsteinen

Fig. 1-3 Joining of basic blocks
 Fig. 4-7 Joining of basic blocks with connection pieces
 Fig. 8 Pivot joint: block 15 with round lugs
 Fig. 9-10 Joining of basic blocks and angular blocks

Fig. 1-3 Assemblage des éléments de base
 Fig. 4-7 Raccordement d'éléments de base à l'aide de languettes d'assemblage
 Fig. 8 Articulation pivotante à l'aide d'un élément de 15 à tourillon
 Fig. 9-10 Assemblage d'éléments de base et d'éléments angulaires

III. 1-3 Esempi d'innesto degli elementi base
 III. 4-7 Unione tra elementi base e pezzi di raccordo
 III. 8 Giunto girevole per mezzo dell'elemento 3 con perno tondo
 III. 9-10 Innesto tra elementi base ed elementi angolari

Afb. 1-3 Verbinden van de basisbouwstenen
 Afb. 4-7 Verbinding van basisbouwstenen met verbindingstuk
 Afb. 8 Draaiverbinding door middel van bouwsteen 15 met ronde noppen
 Afb. 9-10 Verbinden van basisbouwstenen en hoekstenen

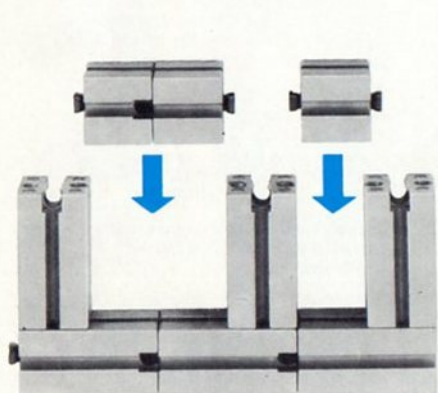

1

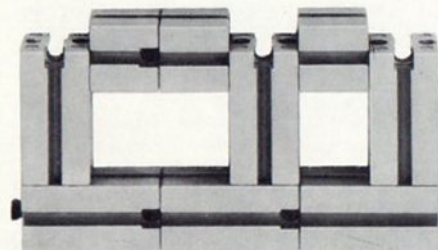

2

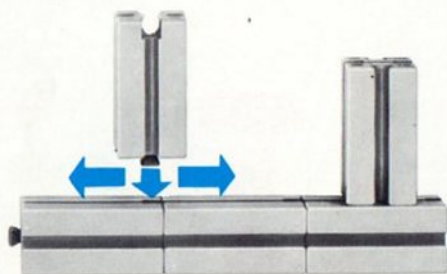

3



4



5

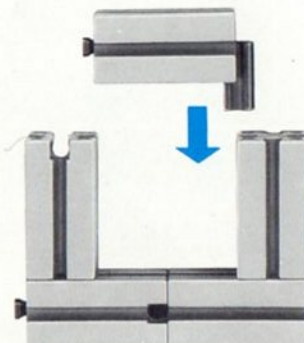

6

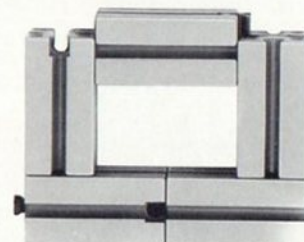

7



8

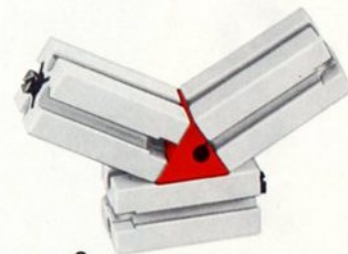

9

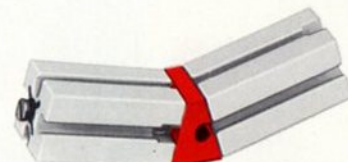

10

Abb. 11 Zusammenfügen von Flachbausteinen und Grundbausteinen
 Abb. 12-12.1 Steckverbindungen der Grundplatten
 Abb. 13 Zusammenbau des Rollenlagers
 Abb. 14 Verbindung von 2 Achsen mittels der Achskupplung
 Abb. 15-16 Naben als Radeinsatz für Reifen
 Abb. 17-18 Anbau der Kurbel und Anbringen von Klemmbuchsen

Fig. 11 Joining of flat blocks and basic blocks
 Fig. 12-12.1 Plug-in connections of base plates
 Fig. 13 Mounting of the roll-bearing
 Fig. 14 Joining to axles with the axle coupling
 Fig. 15-16 Hub as wheel insert for tyre
 Fig. 17-18 Mounting of crank and fitting of clamping sockets

Fig. 11 Assemblage de plaques et d'éléments de base
 Fig. 12-12.1 Assemblage des plaques de base
 Fig. 13 Utilisation du support de poulie
 Fig. 14 Raccord de 2 axes à l'aide du manchon d'accouplement
 Fig. 15-16 Moyeux servant de jantes pour pneus
 Fig. 17-18 Fixation de la manivelle et des bagues de serrage

III. 11 Unione tra elemento piatto ed elementi base
 III. 2-12.1 Unione ad innesto delle piastre fondamentali
 III. 13 Assemblaggio del cuscinetto a rullo
 III. 14 Unione tra due assi per mezzo del raccordo per assi
 III. 15-16 Mozzi in funzione di parti interne delle ruote
 III. 17-18 Modo d'innesto della manovella ed applicazione delle bussole di fissaggio

Afb. 11 Verbinden van plattesteen en basisbouwsteen
 Afb. 12-12.1 Steekverbindingen van de basisplaten
 Afb. 13 Montage rollager
 Afb. 14 Verbinding van 2 assen door middel van de askoppeling
 Afb. 15-16 Naven voor banden
 Afb. 17-18 Monteren kruk en aanbrengen van klemmbussen



Abb. 19 Lösen bzw. Zusammenfügen der Antriebsfeder
 Abb. 20 „Werkzeug“ zum Lockern der Gelenkverschraubung
 Abb. 21–24 Lagerung von Achsen, Wellen und Stangen
 Abb. 25–26 Die Antriebsfeder als Zugmittel

Fig. 19 Untightening and tightening of drive spring
 Fig. 20 "Tool" for loosening the pivot joint
 Fig. 21–24 Bearing of axles, shafts and rods
 Fig. 25–26 The drive spring as traction element

Fig. 19 Assemblage et desserrage du ressort de transmission
 Fig. 20 «Outil» pour desserrer l'articulation
 Fig. 21–24 Logement d'axes, d'arbres et de tiges
 Fig. 25–26 Le ressort de transmission comme moyen d'entraînement

III. 19 Apertura e chiusura della molla per trasmissioni
 III. 20 «Utensile» per allentare l'avvitamento del giunto
 III. 21–24 Supporto di assi, alberi ed aste
 III. 25–26 La molla per trasmissioni come mezzo di trazione

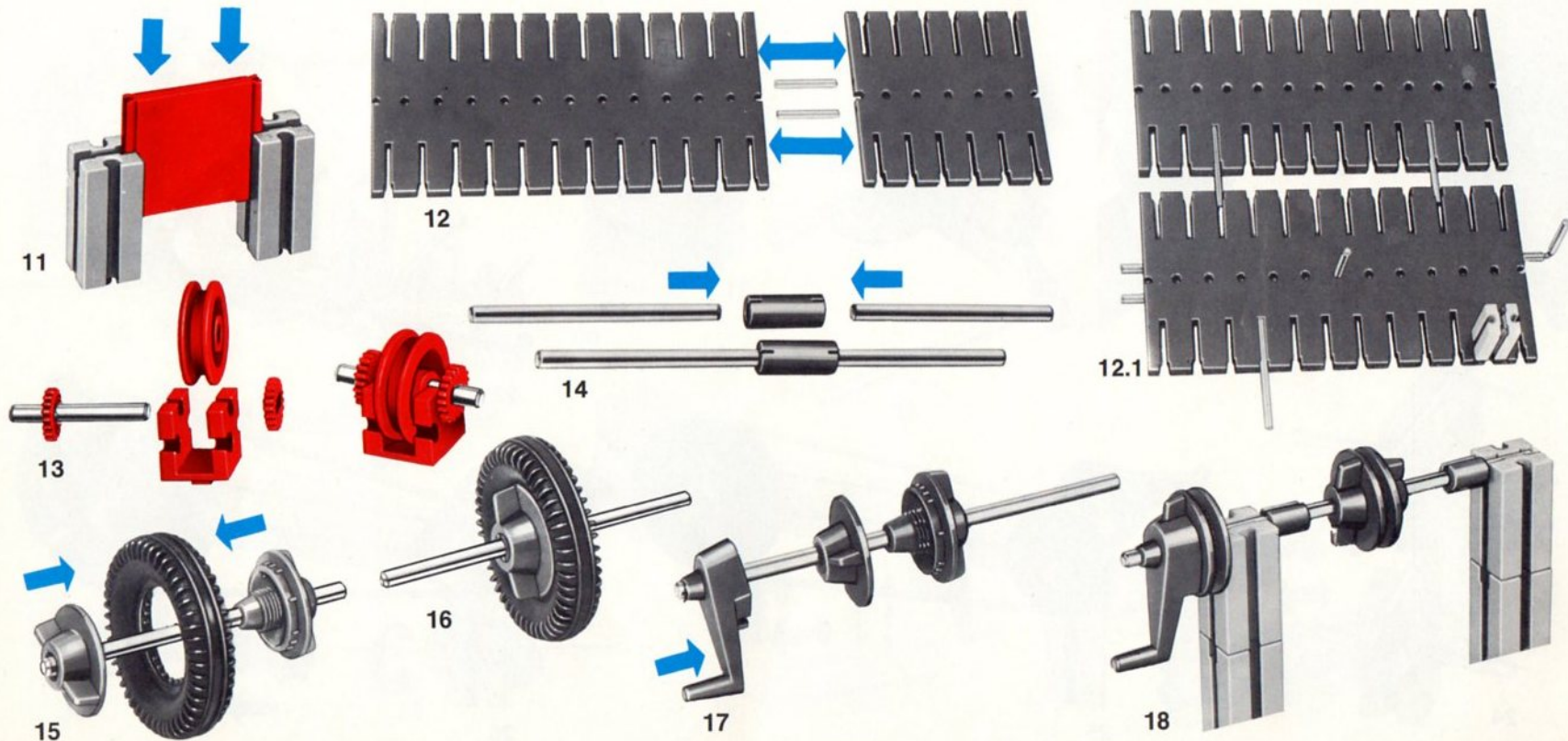
Afb. 19 Los resp. vastmaken van de aandryfveer
 Afb. 20 „Werktuig“ voor het losmaken van scharnierverschroeving
 Afb. 21–24 Berging van assen stangen e. d.
 Afb. 25–26 De aandryfveer als trekmiddel



19



20



21

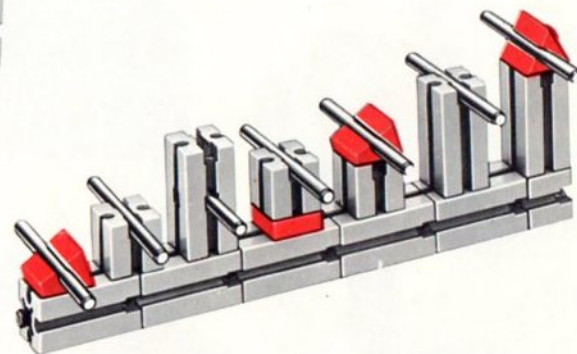

22



23

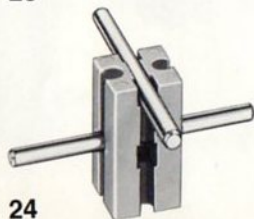

24

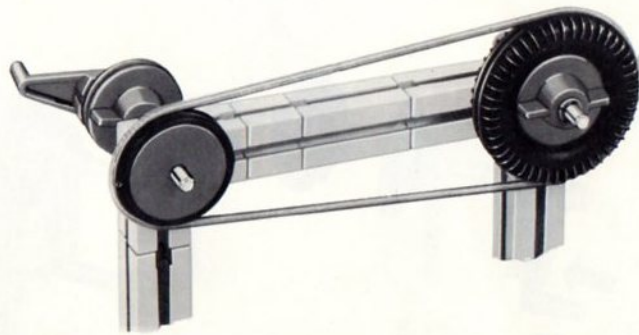

25

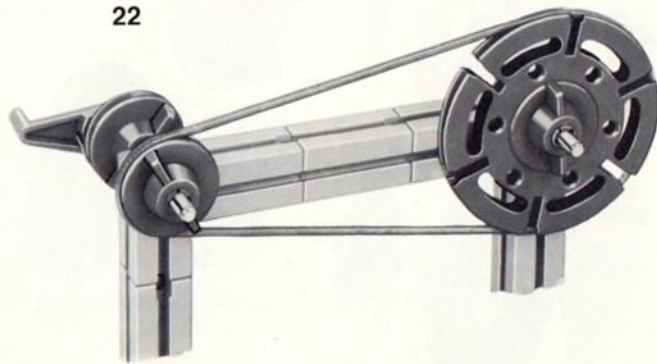

26

Abb. 27-29 Befestigung von Zugseilen auf der Seiltrommel
 Abb. 30-31 Befestigung der Seiltrommel
 Abb. 32-35 Montage der Bauteile mit Klemmverschraubung
 Abb. 36 Arretierung der Seiltrommel
 Abb. 37 Seiltrommel als Klauenkupplung

Fig. 27-29 Fixing traction rope onto rope drum
 Fig. 30-31 Fixing of rope drum
 Fig. 32-35 Assembly of components with clamping joints
 Fig. 36 Stopping of rope drum
 Fig. 37 Rope drum as claw coupling

Fig. 27-29 Fixation du câble tracteur sur le tambour
 Fig. 30-31 Fixation du tambour
 Fig. 32-35 Montage des éléments de construction avec vis de serrage
 Fig. 36 Dispositif d'arrêt du tambour
 Fig. 37 Tambour utilisé comme embrayage à griffes

III. 27-29 Fissaggio di funi traenti sul tamburo
 III. 30-31 Fissaggio del tamburo per funicella
 III. 32-35 Montaggio degli elementi con serraggio a vite
 III. 36 Bloccaggio del tamburo per funicella
 III. 37 Il tamburo per funicella in funzione di innesto a denti frontali

Afb. 27-29 Bevestiging van trekkabel op de kabeltrommel
 Afb. 30-31 Bevestiging van kabeltrommel
 Afb. 32-35 Montage van bouwdelen met klemverschroefing
 Afb. 36 Vastzetten van de kabeltrommel
 Afb. 37 Kabeltrommel als klauwkoppeling



Abb. 38–39 Lagern der Kurbelwelle
 Abb. 40 Kurbelwelle und Anschluß einer Schubstange
 Abb. 41–42 Anbau und Anwendung der Nockenscheibe
 Abb. 43 Klemmring als Distanzscheibe

Fig. 38–39 Crank shaft bearing
 Fig. 40 Crank shaft and connecting rod connection
 Fig. 41–42 Mounting and use of cam disk
 Fig. 43 Clamping ring as spacer disk

Fig. 38–39 Logement du vilebrequin
 Fig. 40 Vilebrequin avec bielle
 Fig. 41–42 Fixation et utilisation d'une came
 Fig. 43 Bague de serrage utilisée comme pièce d'écartement

III. 38–39 Alloggiamento dell'albero a gomiti
 III. 40 Albero a gomiti e collegamento con un'asta di spinta
 III. 41–42 Innesto ed applicazione del disco a camme
 III. 43 Anello di bloccaggio in funzione di disco a spessore

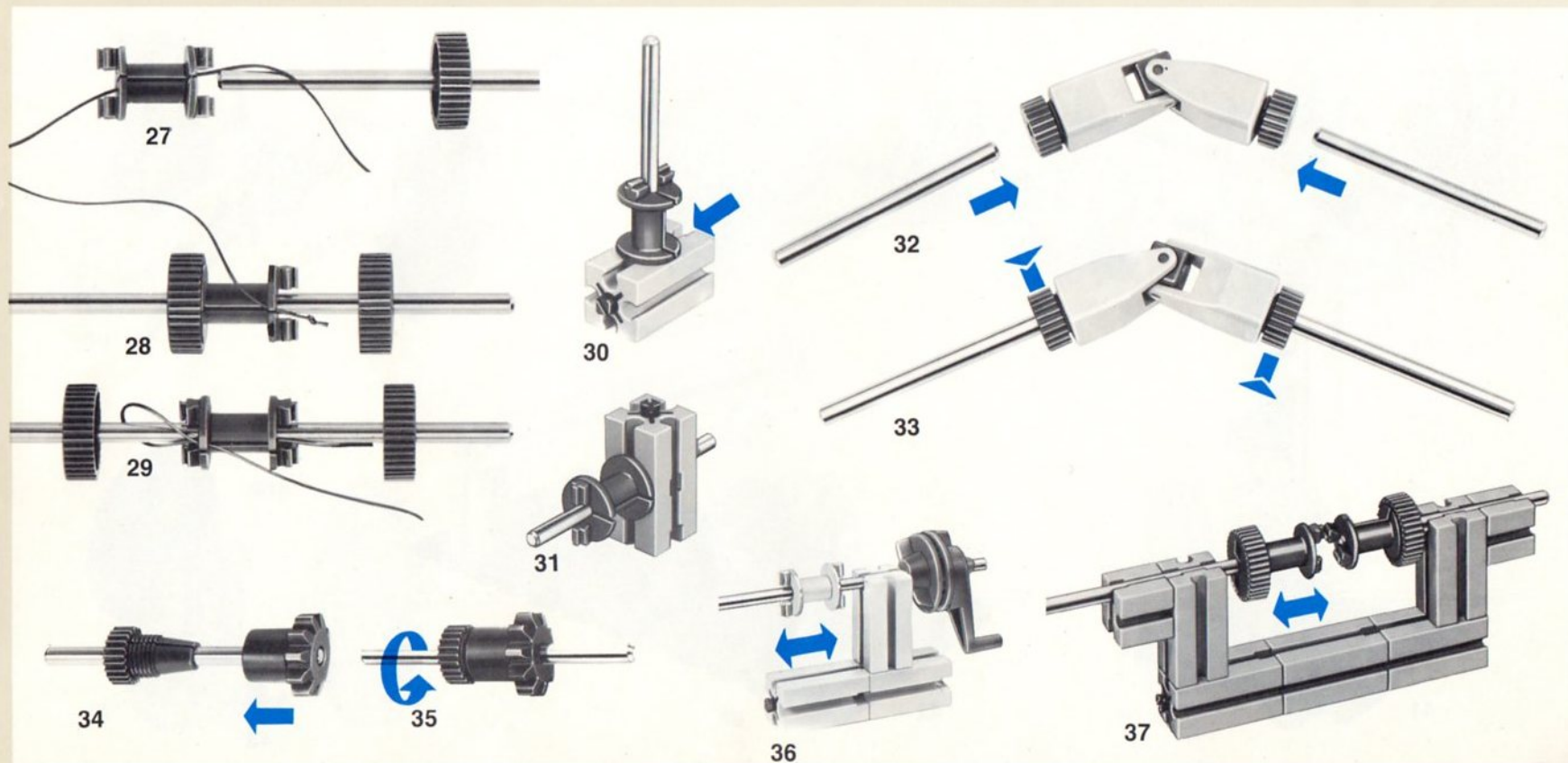
Afb. 38–39 Berging van krukas
 Afb. 40 Krukas en aansluiting van een dryfstang
 Afb. 41–42 Montage en gebruik van een nokkenschyf
 Afb. 43 Klemring als afstandsschyf



Abb. 44–45 Winkelachsen benutzt man als Führung
 Abb. 46 Kolbenstangenantrieb
 Abb. 47–50 Verbindung der Drehscheibe mit anderen Bauelementen

Fig. 44–45 Rightangle axle
 Fig. 46 Piston rod drive
 Fig. 47–50 Connection of rotary disk with other components

Fig. 44–45 Axe coudé
 Fig. 46 Mouvement de piston
 Fig. 47–50 Utilisation de la plaque tournante avec d'autres éléments de construction

III. 44–45 Gli assi ad angolo vengono usati come guide
 III. 46 Comando a biella
 III. 47–50 Collegamento del disco girevole con altri elementi

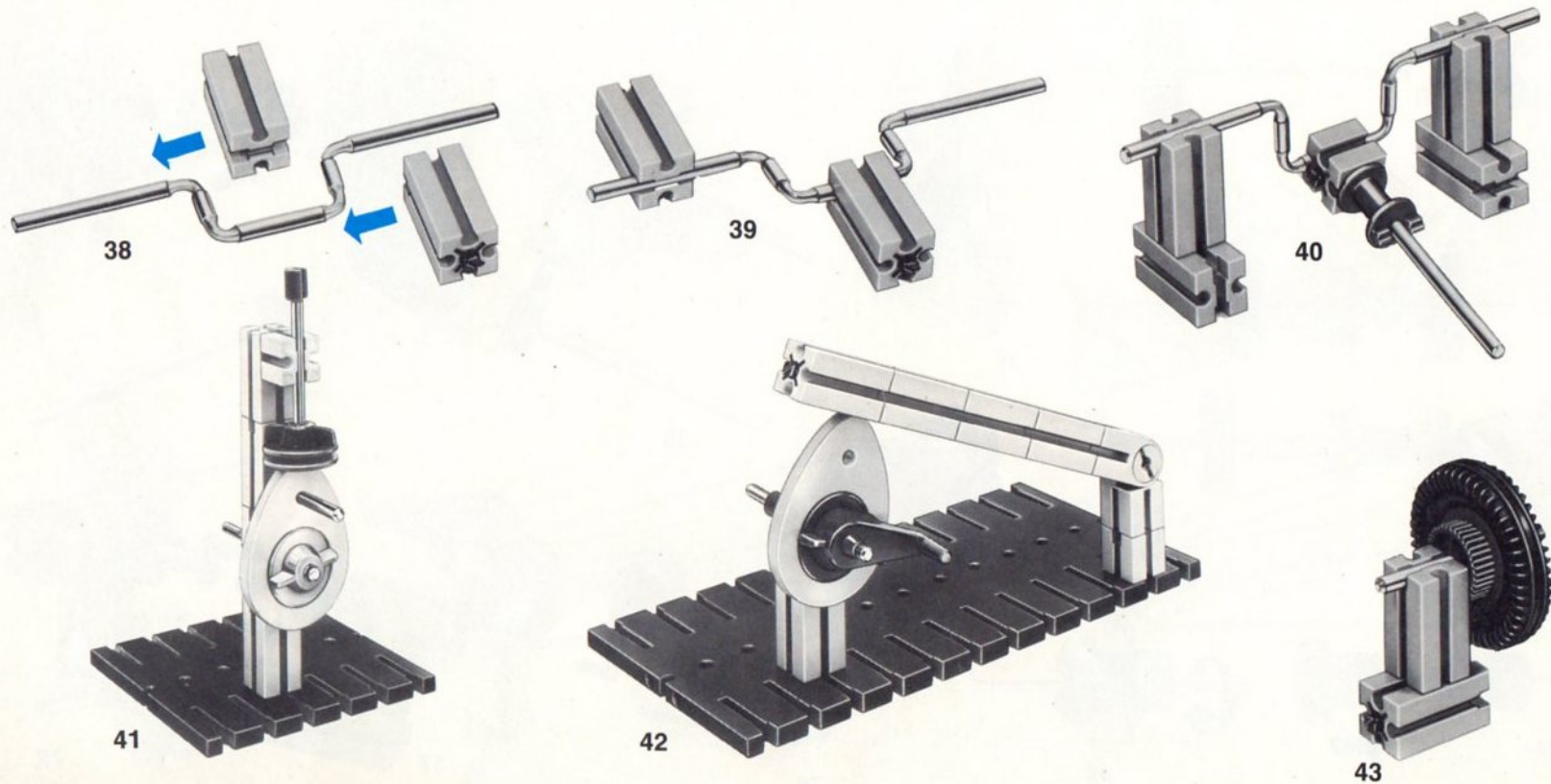
Afb. 44–45 Haakse as
 Afb. 46 Zuigerstangaandrijving
 Afb. 47–50 Verbinding van de draaischijf met andere bouwelementen



Abb. 51 Eingriff zweier Zahnräder
 Abb. 52–53 Das Zahnrad Z 40/32 als Stirn- und Winkelzahnrad
 Abb. 54–55 Einbau und Verwendung der Zahnstange
 Abb. 56 Übertragen einer Drehbewegung im rechten Winkel

Fig. 51 The meshing of two cogwheels
 Fig. 52–53 Gear wheel Z 40/32 as spur and herringbone gear
 Fig. 54–55 Assembly and use of rack
 Fig. 56 Transmission of a rotary movement through a right-angle

Fig. 51 L'entre-axe entre deux roues dentées
 Fig. 52–53 Couronne) 40/32 utilisée comme engrenage à denture droite et angulaire
 Fig. 54–55 Fixation et utilisation de la crémaillère
 Fig. 56 Transmission d'un mouvement de rotation en angle droit

III. 51 Il contatto tra due ruote dentate
 III. 52–53 La ruota dentata Z 40/32 in funzione di ruota dentata cilindrica e ruota dentata angolare
 III. 54–55 Installazione ed applicazione dell'asta dentata
 III. 56 Trasmissione ad angolo retto di un movimento rotativo

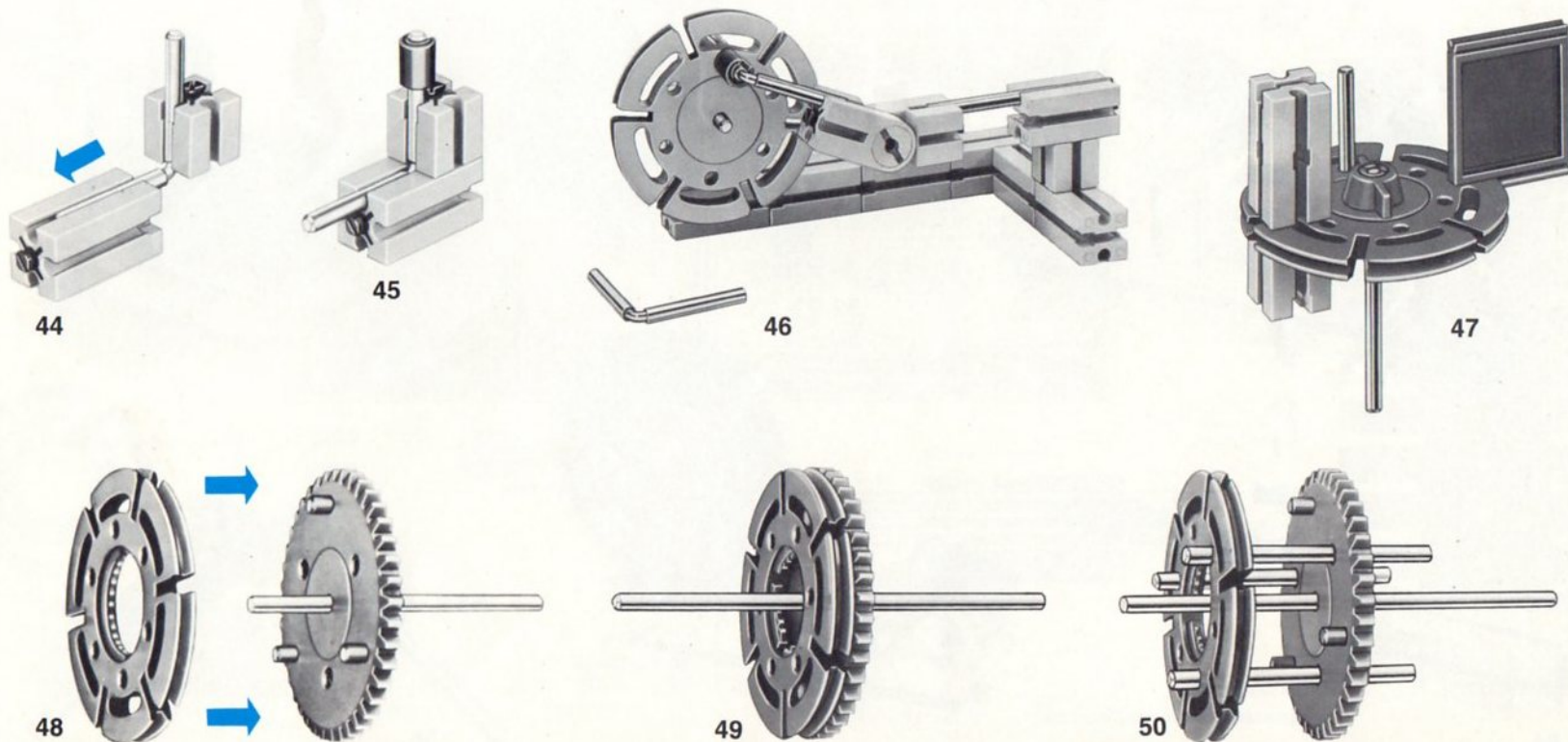
Afb. 51 Het „ingrijpen“ van twee tandwielen
 Afb. 52–53 Het tandwiel Z 40/32 als recht- en hoedstandwiel
 Afb. 54–55 Inbouw en gebruik van de tandheugel
 Afb. 56 Overbrengen van een draai beweging over een rechte hoek

